

テレコム用トランス Telecommunication Transformers

12T SERIES

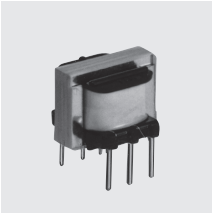

- 小型軽量
 - 自動挿入機対応
 - 最大入力レベル 0 dBm
 - 周波数帯域 300Hz~10KHz
 - 耐電圧 AC500Vr.m.s. 1分間
 - 絶縁抵抗 DC500V 100MΩ以上
 - 最低発注量 100個
- Compact and light weight type
 - Availability of automatic insertion machine
 - MAX. level: 0 dBm
 - Frequency range: 300Hz~10KHz
 - Dielectric strength: AC500Vr.m.s. 1 minute.
 - Insulation resistance: DC500V 100MΩ MIN.
 - Minimum ordering quantity: 100pcs

寸法図 DIMENSIONS (mm)

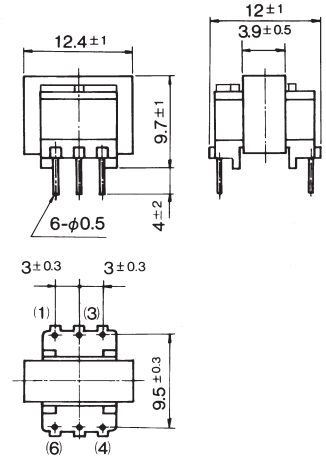

参考質量 Reference Weight 3.3g

ストック マーク Stock mark	カタログ品番 Catalog No.	インピーダンス(Ω) Impedance		Pri. DC (mA)	定損 Loss @1KHz (dB)	周波数特性 Frequency Response (dB)	巻線比 Turns Ratio	D.C.R.(Ω) 約 approx.		結線図 Schematic	備考 Note
		Pri.	Sec.					Pri.	Sec.		
●	12T01	600	600	0	1.7	± 0.7	1:1.00	48	61	1	
●	12T02	600	300	0	1.7	± 0.7	1: 0.707	48	33	1	
●	12T03	600	150	0	1.7	± 0.7	1: 0.500	48	15	1	
●	12T04	300	300	0	2.0	± 0.5	1:1.00	29	36	1	

14T SERIES

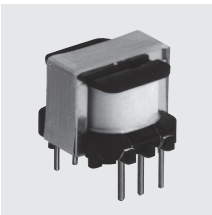

- 小型軽量
 - 自動挿入機対応
 - 断線防止構造
 - 自動生産ライン対応
 - 最大入力レベル +5 dBm
 - 周波数帯域 300Hz~10KHz
 - 耐電圧 AC500Vr.m.s. 1分間
 - 絶縁抵抗 DC500V 100MΩ以上
 - 最低発注量 100個
- Compact and light weight type
 - Availability of automatic insertion machine
 - Availability of automatic production line
 - MAX. level: +5 dBm
 - Frequency range: 300Hz~10KHz
 - Dielectric strength: AC500Vr.m.s. 1 minute.
 - Insulation resistance: DC500V 100MΩ MIN.
 - Minimum ordering quantity: 50pcs

寸法図 DIMENSIONS (mm)

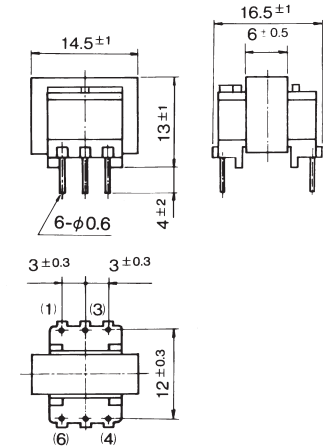

参考質量 Reference Weight 6.0g

ストック マーク Stock mark	カタログ品番 Catalog No.	インピーダンス(Ω) Impedance		Pri. DC (mA)	定損 Loss @1KHz (dB)	周波数特性 Frequency Response (dB)	巻線比 Turns Ratio	D.C.R.(Ω) 約 approx.		結線図 Schematic	備考 Note
		Pri.	Sec.					Pri.	Sec.		
●	14T03	600CT	600CT	0	2.0	± 1.0	1:1.00	64	78	3	
●	14T04	600	600	0	2.0	± 1.0	1:1.00	64	78	1	
●	14T06	600	8	0	2.0	± 1.0	1:0.115	64	0.59	1	
●	14T07	600	600CT	0	1.2	± 0.3	1:1.00	35	45	2	
●	14T08	10K	10K	0	1.7	± 1.0	1:1.00	330	420	1	

12T, 14T SERIES / 結線図

SCHEMATIC

